

PASSED

BEFORE THE BOARD OF COUNTY COMMISSIONERS OF LANE COUNTY, OREGON

ORDINANCE PA 1195) IN THE MATTER OF AMENDING THE RURAL COMPREHENSIVE
) PLAN TO REDESIGNATE LAND FROM "FOREST" TO "AGRICULTURAL"
) AND REZONING THAT LAND FROM "F-2/IMPACTED FOREST LANDS" TO
) "E-25/EXCLUSIVE FARM USE"; AND ADOPTING SAVINGS AND
) SEVERABILITY CLAUSES (file PA 03-5269; Laurelwood Academy)

WHEREAS, the Board of County Commissioners of Lane County, through enactment of Ordinance PA 884, has adopted Land Use Designations and Zoning for lands within the planning jurisdiction of the Lane County Rural Comprehensive Plan; and

WHEREAS, Lane Code 16.400 sets forth procedures for amendment of the Rural Comprehensive Plan, and Lane Code 16.252 sets forth procedures for rezoning lands within the jurisdiction of the Rural Comprehensive Plan; and

WHEREAS, in March 2003, application no. PA 03-5269 was made for a minor amendment to redesignate a 20-acre portion of tax lot 300 of map 18-02-25, from "Forest" to "Agriculture" and concurrently rezone the property from "F-2/Impacted Forest Lands" to "E-25/Exclusive Farm Use; and

WHEREAS, the Lane County Planning Commission reviewed the proposal in public hearing of December 2, 2003, and on that date recommended approval of the proposed amendment and rezoning; and

WHEREAS, evidence exists within the record indicating that the proposal meets the requirements of Lane Code Chapter 16, and the requirements of applicable state and local law; and

WHEREAS, the Board of County Commissioners has conducted public hearings and is now ready to take action;

NOW, THEREFORE, the Board of County Commissioners of Lane County Ordains as follows:

Section 1. The Lane County Rural Comprehensive Plan is amended by the redesignation of a 20-acre portion of tax lot 300 of map 18-02-25, (as described in legal lot determination PA 02-5839) from "Forest Lands" to "Agriculture", such territory depicted on Plan Plot 494 and further identified as Exhibit "A" attached and incorporated herein.

Section 2. Tax lot 300 of map 18-02-25 (as described in legal lot determination PA 02-5839), is rezoned from "F-2/Impacted Forest Lands" (Lane Code 16.211) to "E-25/Exclusive Farm Use" (Lane Code 16.212), such territory depicted on Rural Zoning Plot 494 and further identified as Exhibit "B" attached and incorporated herein.

FURTHER, although not a part of this Ordinance, the Board of County Commissioners adopts Findings as set forth in Exhibit "C" attached, in support of this action.

The prior designation and zone repealed by this Ordinance remain in full force and effect to authorize prosecution of persons in violation thereof prior to the effective date of this Ordinance.

If any section, subsection, sentence, clause, phrase or portion of this Ordinance is for any reason held invalid or unconstitutional by any court of competent jurisdiction, such portion shall be deemed a separate, distinct and independent provision, and such holding shall not effect the validity to the remaining portions hereof.

ENACTED this 31st day of March, 2004.

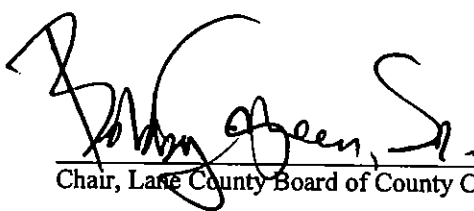
Chair, Lane County Board of County Commissioners

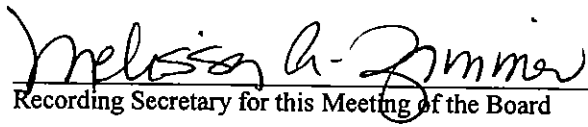
Recording Secretary for this Meeting of the Board

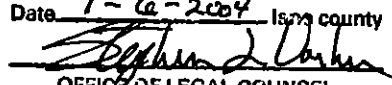
APPROVED AS TO FORM
Date 1-6-2004 Lane county

OFFICE OF LEGAL COUNSEL

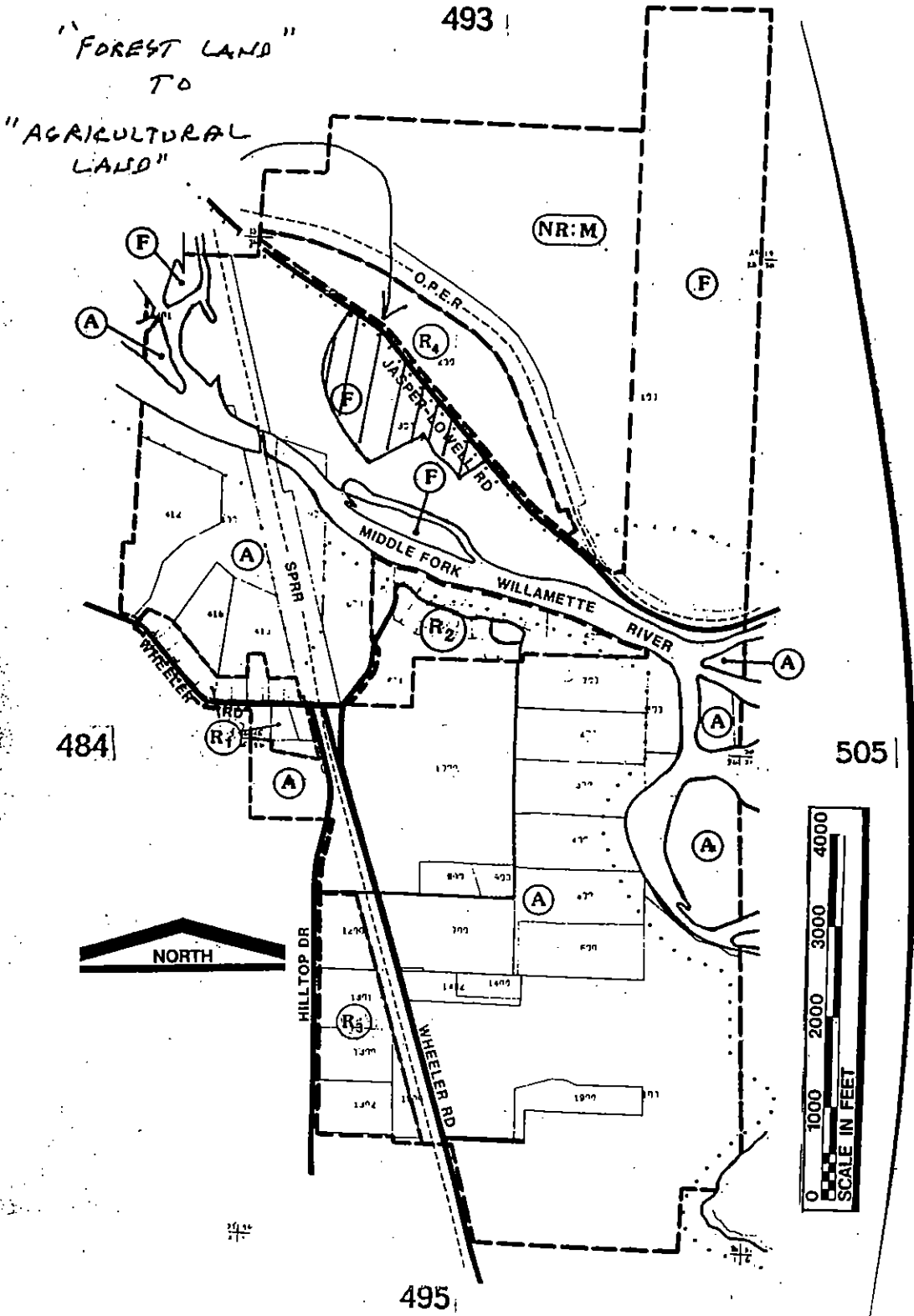
Ordin. PA 1195
Exhibit "A"



OFFICIAL PLAN MAP

PLOT # 494

Township Range Section
 18 02 25 | 18 02 36

ORIGINAL ORD. # _____ PA 884 DATE 2/29/1984 FILE # _____
 REVISION # _____ ORD # _____ DATE _____ FILE # _____

"F-2/IMPACTED FOREST LANDS"
TO

493

"E-25/EXCLUSIVE FARM USE"

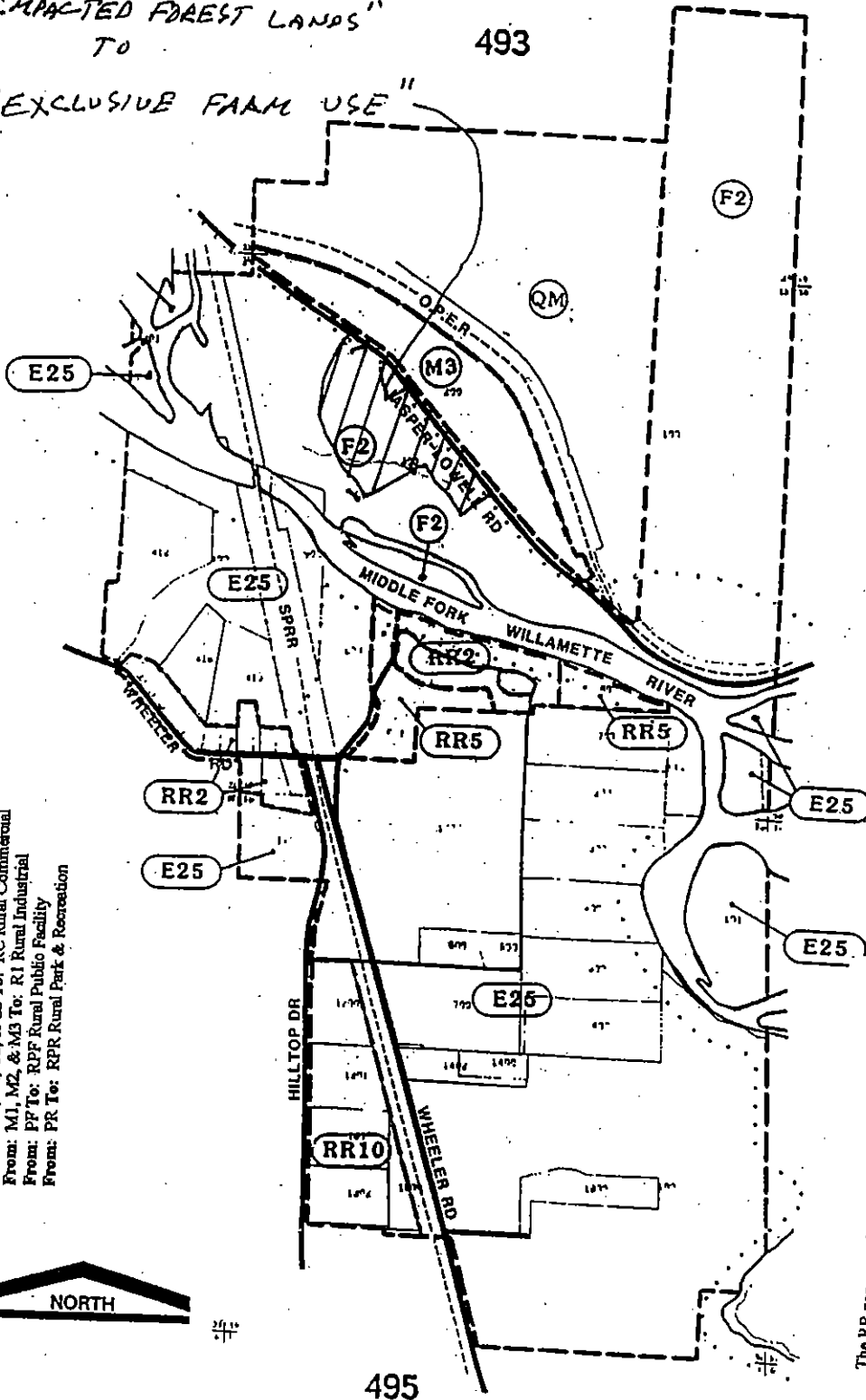

505

The zones on this map are changed as follows:
 From: RG, RA, To: RR2
 From: CR, C1, C2, & C3 To: RC Rural Commercial
 From: M1, M2, & M3 To: R1 Rural Industrial
 From: PF To: RPF Rural Public Facility
 From: PR To: RPR Rural Park & Recreation

The RR zones on this map are changed as follows:
 FROM: RR LC 16.231 TO: RR LC 16.290
 The RR zone period size remains the same.



OFFICIAL ZONING MAP

PLOT# 494

Township Range Section.	
18 02 25	18 02 36

ORIGINAL ORD. # _____ PA 884 DATE 2/29/1984 FILE # _____
 REVISION # _____ ORD # _____ DATE _____

APPLICATION FOR PLAN AMENDMENT AND ZONE CHANGE FROM
FOREST LAND - F-2/FP/GREENWAY(RCP) TO AGRICULTURE LAND
E-25/FP/GREENWAY(RCP)

I. PROPOSAL DESCRIPTION

A. APPLICANT/OWNER

Laurelwood Academy, INC.
3890 S.W. Laurelwood Road
Gaston, OR 97119

B. AGENT

Land Planning Consultants
1071 Harlow Road
Springfield, OR 97477

C. PROPOSAL

* This is an application to change the plan designation and zoning on a 20 acre parcel from ~~Forest Land/F-2~~ to Agriculture Land/E-25. The application would change the classification of the property from one resource zone to another resource zone and does not involve an exception to any Statewide Planning Goal. Existing floodway and greenway overlay zones would be maintained.

II. GENERAL INFORMATION

SITE AND PLANNING PROFILE

A. LOCATION

Map 18-02-25 Tax lot 300 (part)

B. EXISTING ZONING

F-2/FP/Greenway/RCP - Located on Plot 494

C. SITE CHARACTERISTICS

The subject property contains 20 acres located Southwest of Jasper-Lowell Road approximately 2.5 miles Southeast of the Community of Jasper. Approximately 17 acres of the parcel contains orchard and improved pasture.

The remaining 3 acres consists of a small deciduous tree stand and an asphalt surface previously used with a mill operation across Jasper-Lowell Road.

D. SURROUNDING AREA

Land across Jasper Lowell Road to the Northeast is zoned M-3 and contains an operating mill and wood treatment facility.

Land adjacent to the Northwest and South consists of two parcels zoned F-2. The parcel to the South contains a dwelling.

The Middle Fork of the Willamette River is located approximately 450 feet West of the subject parcel. Land West of the river is zoned E-25, RR-5 and RR-2. The Residential zoned land is developed with dwellings.

E. SERVICES - CODE - 1-13

Fire: Dexter Rural Fire Protection District

Police: County, State

Water & Sewer: On-site

School: Pleasant Hill No. 1

Telephone: Qwest

Power: Emerald PUD

Access: Jasper Lowell County Road

Waste Management Site: Glenwood/Rattlesnake

F. BACKGROUND INFORMATION

This parcel was previously a part of larger ownership consisting of approximately 100 acres located between Jasper-Lowell Road and the Middle Fork of the Willamette River. Prior to 1984 the entire ownership was zoned as Farm/Forest (FF-20). In 1984 the entire County underwent a rezoning to achieve Comprehensive Plan acknowledgement from LCDC and this ownership was rezoned to F-2, presumably since the majority had a tree cover and single ownerships were not normally split zoned. At that time application of either farm or forest zoning was of little consequence because the F-2 zone was a mixed use zone that allowed uses within the Farm Use zone. The F-2 zone has since been changed to a strict forest zone.

The subject parcel has historically been used for farm purposes and maintained a farm deferral assessment through 1996. A map and listing of resource capability of soils existing on the parcel are attached to this report. Resource capability is specified by a 1997 publication - Lane County Soil Ratings for Forest and Agriculture.

None of the soils on the parcel are listed as having forest production capability. All soils on the parcel have Class I through IV agriculture ratings which, according to Statewide Planning Goal 3 standards, directs the plan designation of the property as agriculture.

This request would place the subject parcel into the County's Agricultural Lands Inventory in recognition of its capability and its existing and historic use. This change would require application of the provisions within the Exclusive Farm Use zone rather than those of the Impacted Forest zone but would not remove the land from the County's resource lands inventory.

III. APPLICABLE PLAN AMENDMENT CRITERIA AND ANALYSIS

A. LANE CODE 16.400(6)(h)

(iii) The Board may amend or supplement the Rural Comprehensive Plan upon making the following findings:

- (aa) For Major and Minor Amendments as defined in LC 16.400(8)(a) below, the Plan component or amendment meets all applicable requirements of local and state law, including Statewide Planning Goals and Oregon Administrative Rules.**

The plan amendment proposal meets all legal requirements in that it is being processed pursuant to the requirements of Lane Code and the acknowledged Comprehensive Plan. Based upon the factors discussed in this report the subject property will be included within the County's inventory of agricultural land rather than its inventory of forestland. The land will be classified as agriculture land consistent with requirements of Statewide Planning Goal 3, Agriculture Land. No exception to Statewide Planning Goals or application of Administrative Rule is required for a change in resource designation.

- (bb) For Major and Minor Amendments as defined in LC 16.400(8)(a) below, the Plan amendment or component is:**

- (i-i) necessary to correct an identified error in the Plan;**
- or**
- (ii-ii) necessary to fulfill an identified public or community need for the intended result of the component or amendment; or**
- (iii-iii) necessary to comply with the mandate of local, State or federal policy or law; or**
- (iv-iv) necessary to provide for the implementation of adopted Plan policy or elements, or**
- (v-v) otherwise deemed by the Board, for reasons**

briefly set forth in its decision, to be desirable, appropriate or proper.

The amendment proposed meets criterion (i-i) and (iv-iv) above, and with final Board action possibly criterion (v-v).

(i-i) Correction of Error

The subject property and nearby land has a combination of farm and forest characteristics. In 1984 the area was redesignated from Farm/Forest (FF-20) land to forest land and zoned as Impacted Forest Land (F-2) because that zone recognized both agricultural and forest uses. The F-2 zone has since been changed to eliminate the option of applying certain provisions of the EFU zone. As discussed in more detail in other sections of this report, the parcel is more accurately defined as agricultural land than forestland and should be designated and zoned accordingly.

(iv-iv) Plan Policy Direction

Lane County Comprehensive Plan Policy 5 under Goal 3 states “Use planning and implementation techniques that reflect appropriate uses and treatment for each type of land”. The land proposed for redesignation to agriculture is and has historically been used for farm purposes. Under the intent of this Policy the plan designation and zoning should be made consistent with that use.

(cc) For Minor Amendments as defined in LC 16.400(8) (a), the Plan amendment or component does not conflict with adopted Policies of the Rural Comprehensive Plan, and if possible, achieves policy support.

Comprehensive Plan Policies have been developed for each of nineteen Statewide Planning Goals to provide guidance and direction for County actions and decisions pursuant to these Goals. Policies directly applicable to this amendment are those found under Goals 3 and 4 since it involves a change in designation from forest to agriculture. As stated above, Policy 5 of Goal 3 provides support for the designation of land to reflect its use. The amendment does not conflict with any of the Goal 3 or Goal 4 Policies. The amendment does not conflict with any other of the Plan Policies in that those policies either do not apply or are administered through Lane Code provisions regulating specific land uses and applications.

(dd) For Minor Amendments as defined in LC 16.400(8) (a), the Plan amendment or component is compatible with the existing structure of the Rural Comprehensive Plan, and is consistent with the unamended portions or elements of the Plan.

The plan amendment requested follows the existing structure of the Comprehensive Plan. No land use designations which do not now exist are being requested. By virtue of being a Minor Amendment, the impact of the proposal will be site specific and consistent with unamended portions of the plan diagram. As discussed above, the request complies with the existing Comprehensive Plan and therefore is consistent with the unamended elements of the plan.

B. LANE CODE 16.400(8)

(a) Amendments to the Rural Comprehensive Plan shall be classified according to the following criteria:

(1) Minor Amendment: An amendment limited to the Plan Diagram only and, if requiring an exception to Statewide Planning Goals, justifies the exception solely on the basis that the resource land is already built upon or is irrevocably committed to other uses not allowed by an applicable goal.

The amendment is limited to the plan diagram only and does not involve an exception to any Statewide Planning Goals. It therefore qualifies as a Minor Amendment for purposes of this review.

(c) Minor Amendment proposals initiated by an applicant shall provide adequate documentation to allow complete evaluation of the proposal to determine if the findings required by LC 16.400(6)(h)(iii) can be affirmatively made. Unless waived in writing by the planning director, the applicant shall supply documentation concerning the following:

(i) A complete description of the proposal and its relationship to the Plan.

The proposal is a redesignation of the subject 20 acre parcel from Forest Land to Agriculture Land. This will include a revision of the plan map for this property only and will cause application of the Plan Policies for Goal 3 rather than Goal 4.

(ii) An analysis responding to each of the required findings of LC 16.400(6)(h)(iii).

This analysis provided in the previous section III. A of this report.

(iii) An assessment of the probable impacts of implementing the proposed amendment, including the following:

(aa) Evaluation of land use and ownership patterns of the area of the amendment;

A description of adjacent and nearby property is provided in the introductory portion of this report. There are neither large blocks of forest land or of agricultural land within the nearby vicinity. It is a mosaic pattern of zoning classifications including farm, forest, residential, industrial and quarry mining. The land located between Jasper-Lowell Road and the Middle Fork of the Willamette River that includes the subject parcel contains approximately 150 acres and is zoned F-2. Land across the river is a mixture of Rural Residential and Exclusive Farm Use (E-25) zoning. Land across from Jasper-Lowell is zoned Industrial (M-3) and Quarry Mining (QM).

(bb) Availability of public and/or private facilities and services to the area of the amendment, including transportation, water supply and sewage disposal;

Access to the property is by Jasper-Lowell County Road. Water is available by the use of an existing on-site well which is shown by well log records to produce 60 gallons per minute. Oregon Water Resources Division records show 38 wells within Section 25 with an overall average flow of 17.5 gallons per minute. The property is located within the Emerald Peoples Utility district and Qwest Communications, both of which have facilities along the Jasper-Lowell Road right-of-way. Sewage disposal is not a requirement for changing a designation from forest to agriculture.

(cc) Impact of the amendment on proximate natural resources, resource lands or resource sites, including a Statewide Planning Goal 5 "ESEE" conflict analysis where applicable;

There are no identified Goal 5 resources on the site and a Goal 5 ESEE analysis is therefore not applicable. Proximate resource lands are forest lands and agricultural lands. This change from forest land to agriculture land is compatible with the nearby lands which are designated as resource lands and does not create a potential conflict between uses. The parcel is located within the Willamette Greenway which does not affect its designation as agriculture. Any future special use of the parcel would require consideration under Lane Code 16.259. (Willamette Greenway Permit)

(dd) Natural hazards affecting or affected by the proposal;

As shown on panel 1660, Lane County Flood Insurance Rate Maps, the property is located within the 100 year flood plain. There are no other known natural hazards which exist on or near the subject property. Location within the flood plain does not affect designation of the parcel as agriculture but would require a special use permit approval before any structure could be placed on the property.

(ee) For a proposed amendment to a nonresidential, nonagricultural or nonforest designation, an assessment of employment gain or loss, tax revenue impacts and public service/facility costs, as compared to equivalent factors for the existing uses to be replaced by the proposal;

This criterion does not apply to amendments for Agriculture and Forest designations.

(ff) For a proposed amendment to a nonresidential, nonagricultural or nonforest designation, an inventory of reasonable alternative sites now appropriately designated by the Rural Comprehensive Plan within the jurisdictional area of the Plan and located in the general vicinity of the proposed amendment;

This criterion does not apply to amendments for Agriculture and Forest designations.

(gg) For a proposed amendment to a Nonresource designation or a Marginal Land designation, an analysis responding to the criteria for the respective request as cited in the Plan document entitled, "Working Paper: Marginal Lands" (Lane County, 1983)

This amendment is not for a nonresource or marginal land designation and the working paper is therefore not applicable.

IV. APPLICABLE ZONE CHANGE CRITERIA AND ANALYSIS

B. LANE CODE 16.252(2) - ZONINGS AND REZONINGS

This section of the Code requires that rezonings be 'enacted to achieve the general purposes of the Chapter and shall not be contrary to the public interest'. They are also to be consistent with the specific purposes of the proposed zone, applicable plan elements and Statewide Planning Goals for which the County has not yet achieved acknowledgment. The variety of criteria involved in a Plan Amendment proceeding, which in this case must precede the zone change, assures that the zone change is correctly carried out and that it is in compliance with the numerous purpose of the Chapter 16 and the intent of the Exclusive Farm Use zone.

Lane Code 16.212(9) specifies that land within the Exclusive Farm Use zone be designated as E-25, E-30, E-40 or E-60 as determined by Plan Policy 10 of Goal 3. Policy 10 states that the minimum area requirements be in accordance with that established by the Addendum to Working Paper; Agricultural Lands. The Working Paper establishes either 25, 30, 40 or 60 acre minimums for each of the

18 farm regions. The subject property is located within Region 18 which has a 25 acre minimum area requirement. The property will therefore be zoned E-25.

Since applicable portions of the County Rural Comprehensive Plan are acknowledged, no Statewide Planning Goal examination beyond that provided in connection with the Plan Amendment is required.

V. OTHER ASSOCIATED ISSUES

LC 16.005(4) Habitat

As shown on Lane County's Comprehensive Plan Map for Wildlife Habitat (Lowell), no inventoried wildlife habitat sites are located on or near the proposed homesite.

ORS 215.418 Wetlands

As shown on National Wetlands Inventory Map (Jasper 1), no wetlands exist on the subject parcel.

Legal Lot Status

Planning Action Number PA 02-5839 has verified that the parcel is a legal lot resulting from a property line adjustment recorded October 15, 2002 as Instrument No. 079700.

VI. CONCLUSION

The result of this amendment would be to change the resource designation of the 20 acre parcel involved from Forest to Agriculture. The change is supported by soil types existing on the parcel which are not rated as forest soils but are rated as Class I, II and IV agricultural soils. Use of the parcel has historically been agriculture as opposed to forestry. It has never been assessed as forest land but has, in the past been assessed as farm land.

Based upon these factors the parcel should be designated as Agriculture on the Comprehensive Plan diagram and zoned as Exclusive Farm Use.

VII. ATTACHMENTS

Assessors map of parcel
LCOG soils map
Letter from Assessment and Taxation
Wetland map Jasper 1
Wildlife habitat map Lowell
Floodplain map #1660
Zoning map
Legal lot verification/PA 02-5839

Deed of ownership
1982 aerial photo
2001 aerial photo

ection 25 T.18S. R.2W.WM.

LANE COUNTY

(1"=400')

18 02 25

B-L-04
-DIV. GEO. & C. 2000
(ADJUST 905 TO 1000)

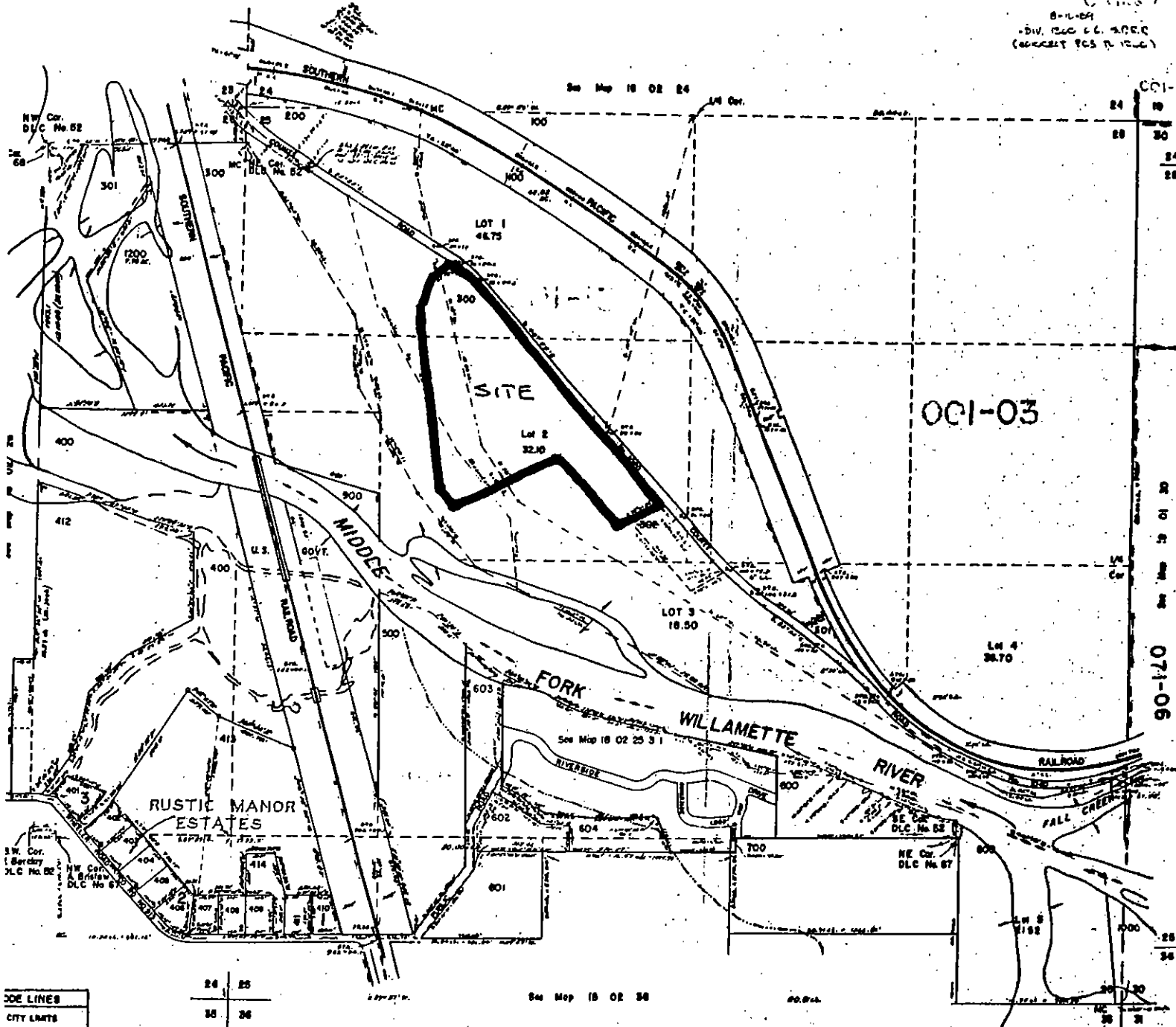

001-03

001-0

071-06

--- JOE LINES
 --- CITY LIMITS
 --- SCHOOL BOUNDARY
 --- ALL OTHER CODES

24	25
28	26

See Map 18 02 24

NO. 014

28 30

SOIL MAP

300

200

48

200

22

300

95

2

1

AGRICULTURE
R
CAPABILITY
CA

High Value

Hi-val if

Hi-val if

Potential

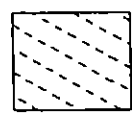
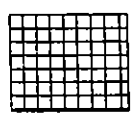
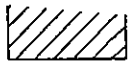

95

95

W

900

114

900

400

400

500

43C

600

5

48

SOIL MAP

413

Scale 1:4800



February 18, 2003

Mike Evans
Land Planning Consultants
1071 Harlow Road
Springfield, OR 97477

Re: Map Number 18-02-25-00, Tax Lot Number 00300
Account Numbers 1342227 and 0572162

Mike,

As per your request, this department has conducted a research of the file for farm and forest assessment records for the above referenced accounts.

Records are limited for an extended history of past property assessments. Those readily available indicate that approximately 55 acres of account number 1342227 and 12 acres of account number 0572162 have been, and currently are, assessed as designated forestlands. Based on a review of our soil maps, the indicated portion shown on the map you provided has not been assessed as forestland and, for at least the years of 1995 and 1996, it received farm deferral special assessment. This portion is not currently receiving either farm or forest special assessment.

We hope this information proves useful to you.

Sincerely,

Pat Woodward
Farm/Forest Club



NATIONAL
WETLANDS
INVENTORY

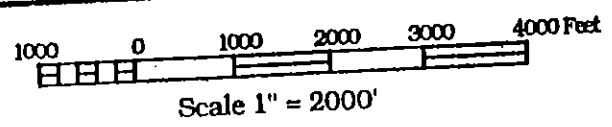

Jasper 1

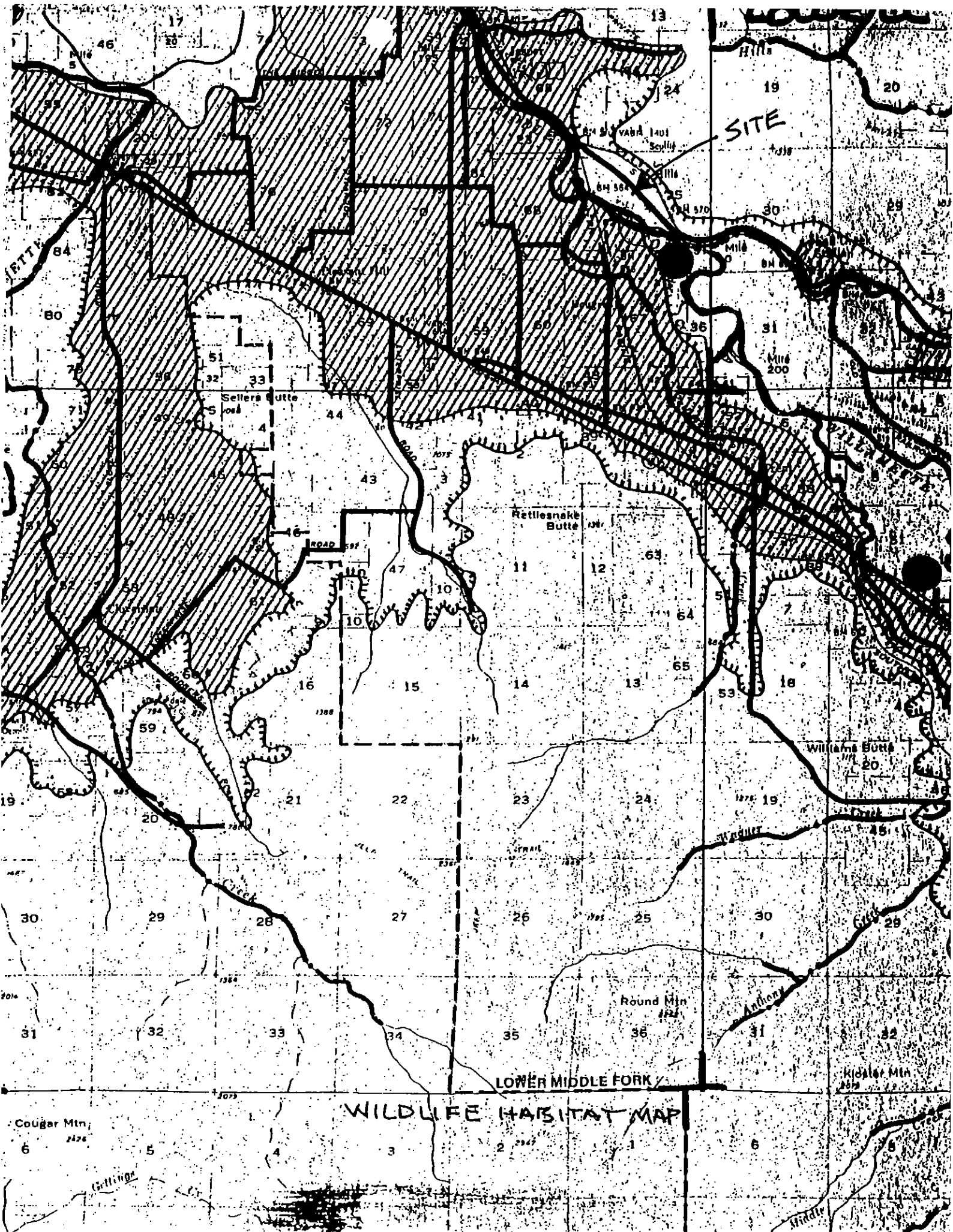

SITE

WILDLIFE HABITAT MAP

LOWER MIDDLE FORK

Cougar Mtn
2426

Round Mt
1922

Kidder Mt
2629

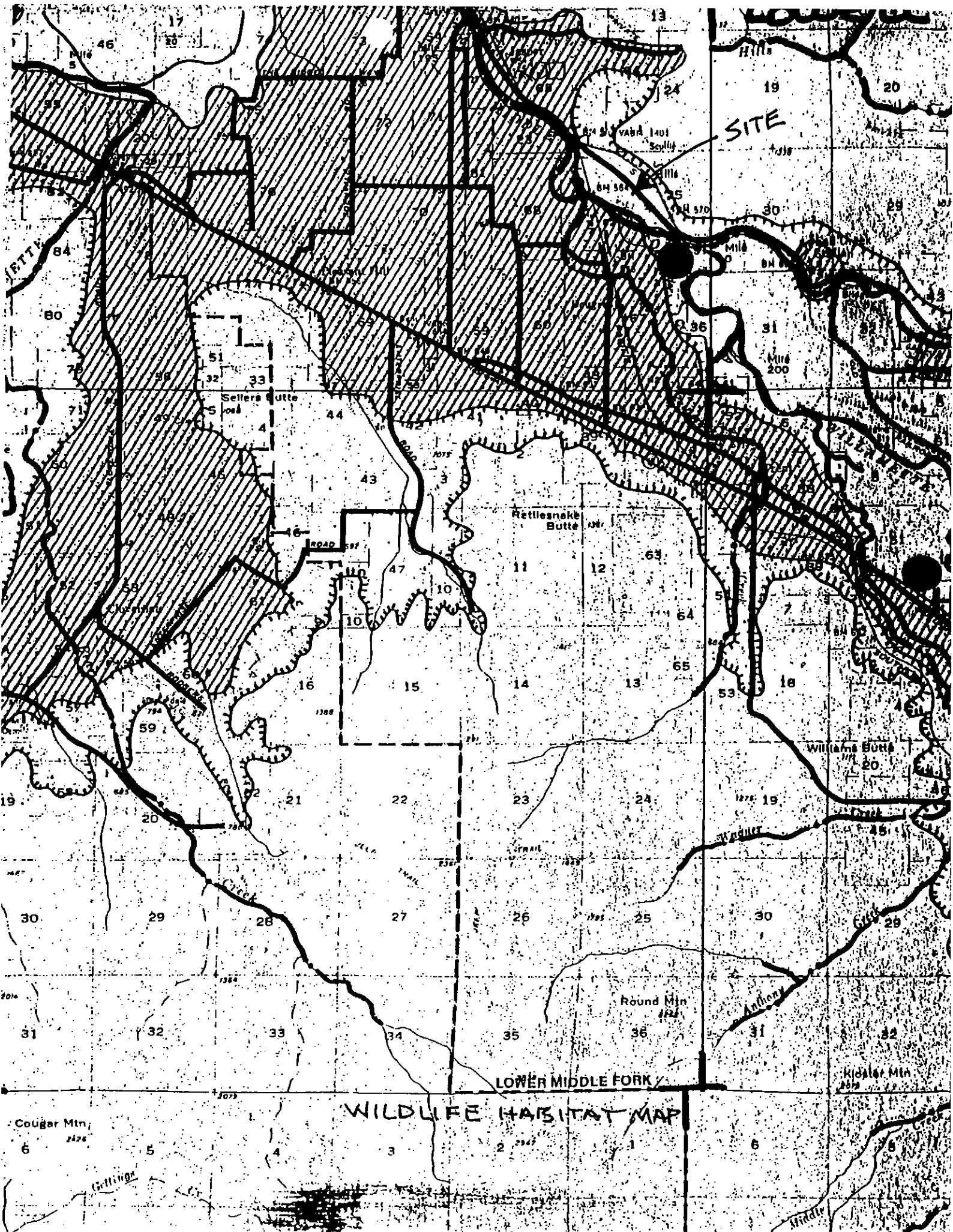

3

4

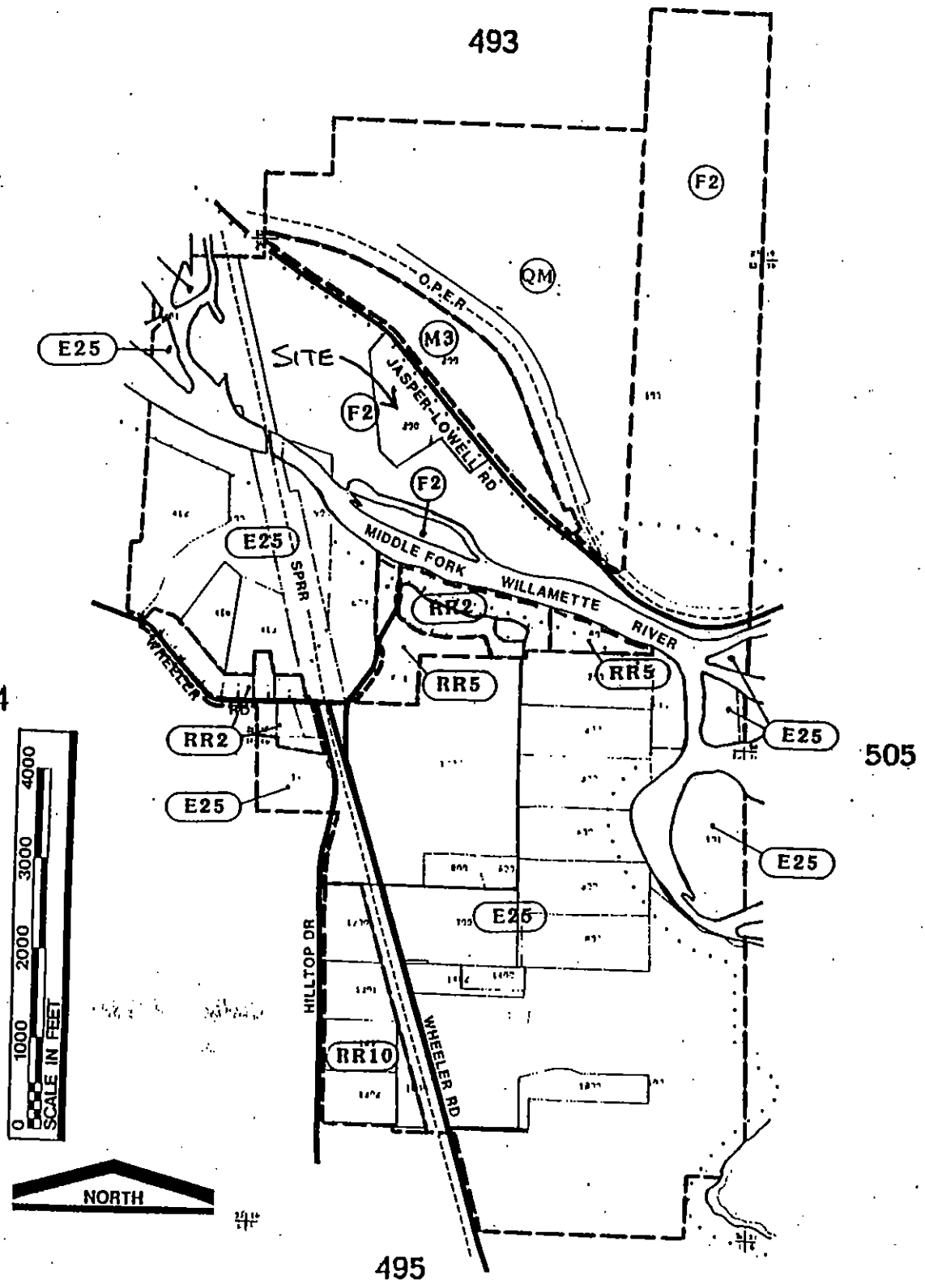

OFFICIAL ZONING MAP

PLOT# 494

Township Range Section
 18 02 25 / 18 02 36 ()

ORIGINAL ORD. # _____ PA 884 DATE 2/29/1984 FILE # _____

REVISION # _____ ORD # _____

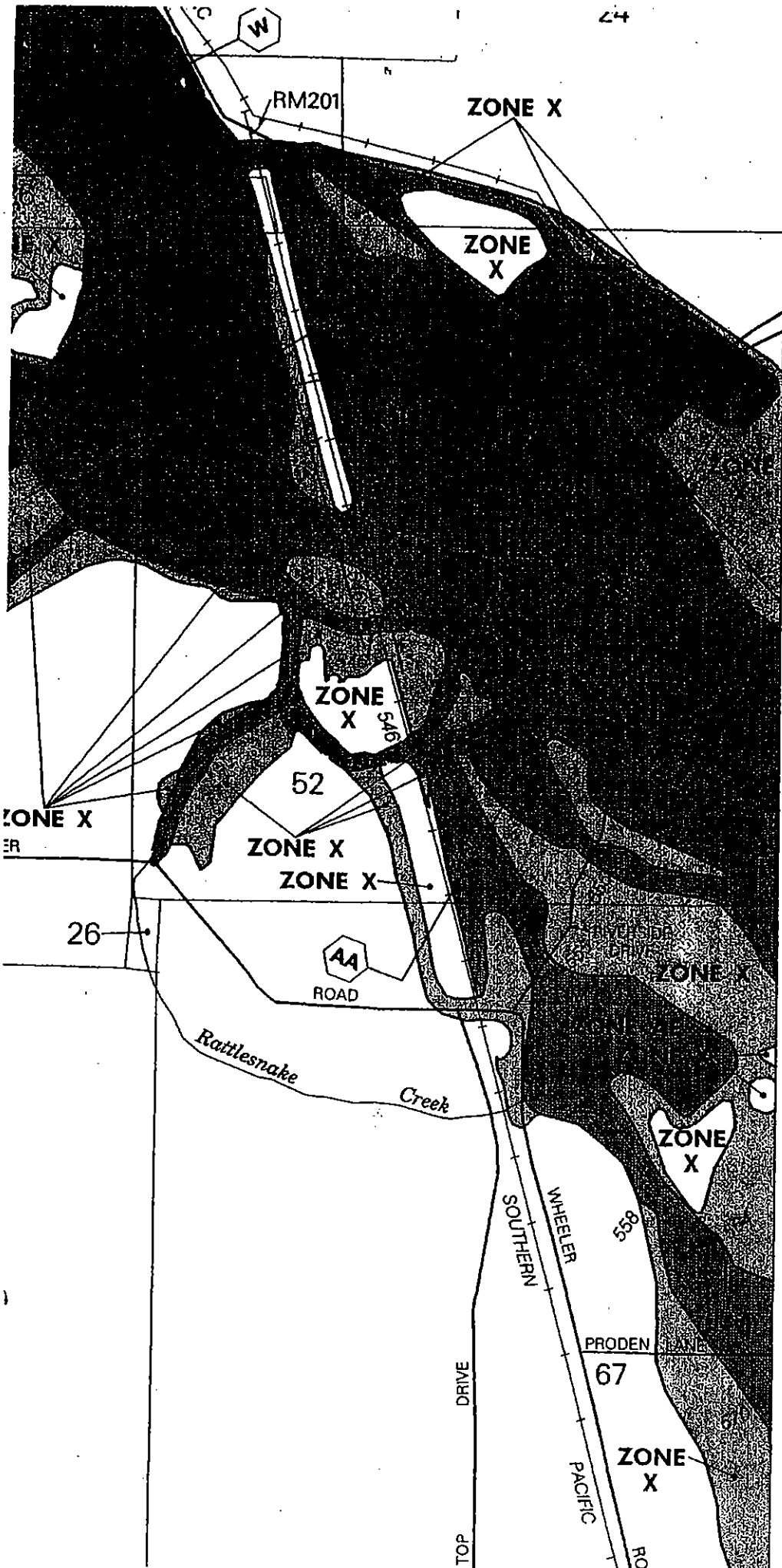

PANEL 1660
FLOOD PLAIN
MAP

- 5
- 5
- (EL
RI
•
97°07'30"

This map is for
it does not nec
local drainage
Special Flood
consulted for
floodway deline
construction pu

Areas of Spec
A30, AH, AO, AS

Certain areas
flood control s

Boundaries of
interpolated be
hydraulic consi
Emergency Ma

Floodway width
to Floodway D:

Coastal base flo
the effects of
from those c
evacuation plan

Corporate limits
should contact
limits have c

This map may
Resource Syste
under the Coe

For community
Section 8.0 of

For adjoining n
Map Index.

R

COUN

EFFECTIVE

Refer to the Fl
on this map t
zones where el

To determine if
call the Nationa

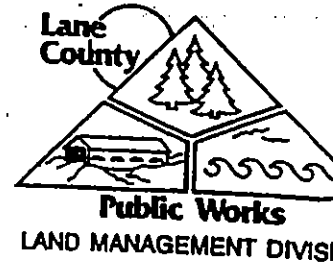

Date: OCT. 19, 2002

APPLICANT: LAND PLANNING CONSULTANTS
1071 HAYLAW ROAD
SPRINGFIELD, OR. 97177

OWNER: MCDUGAL BROS. INVESTMENTS
P.O. BOX 578
CRESWELL, OR. 97126

PA: 02-5839

RE: Report and Verification of a Legal Lot
Tax Map: 1 B 02-25-00 Taxlot: 300 (REVISED 20+ AC)
PARCEL

A more exact description by reference to Deed or Land Sales Contract
is DOCUMENT # 2002-079700.

Based upon the Findings provided in this report, the above referenced property constitutes a legal lot, which means:

1. Ownership to this property may be conveyed with the assurance that such a conveyance would not require approval by Lane County land division regulations; and
2. Lane County recognizes this property as a legally separate unit of land for the purposes of development. Development would still be subject to applicable zoning, sanitation, access and building regulations.

Findings

1. The subject property was created as a separate parcel on OCT. 14, 2002.
See attached instruments DOCUMENT # 2002-079700
2. The creation of the subject property as a separate parcel complied with all effective land division, zoning and comprehensive plan regulations, and it therefore constitutes a legal lot:

a. Land division regulations:

[] When the subject parcel was created, there were not land division regulations in effect to govern its creation. Lane County did not adopt applicable regulations for this kind of division until _____.

There were land division regulations in effect governing the creation of this parcel, and the creation of this parcel was specifically exempted by these regulations from compliance because THIS IS A PROPERTY LINE ADJUSTMENT THAT IS ALLOWED PER ORS CHAPTER 92 OF 2 LEGAL LOTS SEE PD# 02-5062 AND 5063.

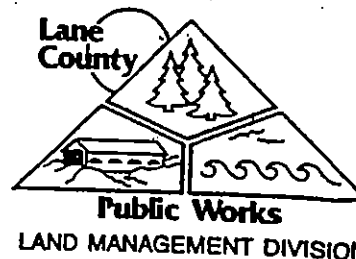

b. Zoning regulations:

- [] When the subject parcel was created, there were no zoning regulations in effect at this time. The zoning for this property was adopted on _____.
- (4) When the subject parcel was created, there were the following zoning regulations in effect which the parcel complied with because THE ORIGINAL AND REVISED PARCEL IS SUBSTANDARD TO THE F-2 ZONE. LANE COUNTY POLICY ALLOWS PROPERTY LINE ADJUSTMENT OF SUBSTANDARD PARCELS.

c. Additional Comments:

THE REQUIREMENT OF THE STATE LAW FOR PROPERTY LINE ADJUSTMENT PER ORS CHAPTER 92 HAS BEEN COMPLETED; SEE ENCLOSED COPIES OF THE RECORDED DEED ON DOCUMENT NO 2002-079700 AND SURVEY MAP AS FILED IN THE SURVEYORS OFFICE. COUNTY ROAD 1070 PROVIDES ACCESS.

"This is a preliminary indication that the above referenced property, as further designated on the enclosed map, is a legal lot. The decision that this property constitutes a legal lot will be made at the time of the first permit or application action where a legal lot is required. If the boundaries of this legal lot have changed at the time of a permit or application which requires a legal lot, a new Legal Lot Verification will be required."

Sincerely,

A large, stylized handwritten signature in black ink, appearing to read "D. G. Nickell".

D. G. NICKELL P.L.S.O.
Engineering Associate
541-682-3989

ATTACHMENTS

CC: TRS File

AFTER RECORDING RETURN TO
FIDELITY NATIONAL TITLE INSURANCE
COMPANY OF OREGON
PO BOX 10827
EUGENE, OR 97440

Division of Chief Deputy Clerk
Lane County Deeds and Records

2002-079700



\$36.00

10/15/2002 09:29:12 AM

RPR-DEED Cnt=1 Stn=6 CASHIER 01
\$15.00 \$11.00 \$10.00

After Recording Return To:

Send Tax Statements To:
McDougal Bros. Investments
P.O. Box 518
Creswell, OR 97426

DECLARATION OF PROPERTY LINE ADJUSTMENT

McDougal Bros. Investments a General Partnership consisting of Norman N. McDougal and Melvin L. McDougal, (McDougal) is the owner of two adjoining parcels of property referred to herein as Parcel A and Parcel B. McDougal is setting forth this Declaration to set adjusted boundary-lines between Parcel A and Parcel B to comply with Lane County Land Use Regulations and the provisions of ORS 92.190(4).

The reference to the legal description of the Parcel A property prior to this adjustment is the deed recorded August 27, 1931 in Book 171 Page 299 Lane County Oregon Deed Records. Parcel A is a legal lot verified by Lane County Planning Action Number PA 02-5062.

References to the legal description of the Parcel B property prior to this adjustment is the deed recorded May 4, 1948 in Book 372 Pages 328 through 333 and Circuit Court Case No. 69968 Decree recorded October 23, 1963 on Reel 92 Page 945, Lane County Oregon Deed Records. Parcel B is a legal lot verified by Lane County Planning Action Number PA 02-5063.

The new common boundary line between Parcel A and Parcel B is underlined in the description of Parcel A below.

The revised Parcels A and B after this adjustment are described as follows:

PARCEL A
(REVISED PARCEL 2)

BEGINNING AT A POINT 969.0 FEET SOUTH AND 1270.7 FEET WEST OF THE NORTH 1/4 CORNER OF SECTION 25, TOWNSHIP 18 SOUTH, RANGE 2 WEST, WILLAMETTE MERIDIAN, SAID POINT BEING IN THE CENTER OF COUNTY ROAD NO. 1020(AS TRAVELED) THENCE S30°20'40"W A DISTANCE OF 405.80 FEET, THENCE S08°28'59"E A DISTANCE OF 921.13, THENCE S34°16'16"E A DISTANCE OF 150.96 FEET, THENCE N62°02'09"E A DISTANCE OF 643.61 FEET, THENCE S42°27'16"E A DISTANCE OF 514.12 FEET, THENCE N58°21'04"E A DISTANCE OF 294.86 FEET TO THE CENTER OF SAID COUNTY ROAD NO. 1020(AS TRAVELED), THENCE NORTHWESTERLY ALONG THE CENTER OF SAID COUNTY ROAD NO. 1020 A DISTANCE OF 1760 FEET, MORE OR LESS, TO THE POINT OF BEGINNING ALL IN LANE COUNTY, OREGON. EXCEPTING THEREFROM ANY PORTION LYING IN THE RIGHT OF WAY OF COUNTY ROAD NO. 1020.

02/10-25 1/3

This instrument filed for record by Fidelity National Title Company as an accommodation only. It has not been examined as to its execution or as to its effect upon the title.

PARCEL B
(REVISED PARCEL 3)

BEGINNING AT A POINT 969.0 FEET SOUTH AND 1270.7 FEET WEST OF THE NORTH ¼ CORNER OF SECTION 25, TOWNSHIP 18 SOUTH, RANGE 2 WEST, WILLAMETTE MERIDIAN, SAID POINT BEING IN THE CENTER OF COUNTY ROAD NO. 1020 (AS TRAVELED) THENCE S30°20'40"W A DISTANCE OF 28.62 FEET TO A POINT ON THE SOUTHERLY RIGHT OF WAY OF SAID COUNTY ROAD NO. 1020, SAID POINT BEING THE TRUE POINT OF BEGINNING, THENCE S30°20'40"W A DISTANCE OF 377.18 FEET, THENCE S08°28'59"E A DISTANCE OF 921.13, THENCE S34°16'16"E A DISTANCE OF 150.96 FEET, THENCE N62°02'09"E A DISTANCE OF 643.61 FEET, THENCE S42°27'16"E A DISTANCE OF 514.12 FEET, THENCE N58°21'04"E A DISTANCE OF 65.11 FEET TO THE SW CORNER OF PARCEL 1 OF M394-75, THENCE S41°54'18"E ALONG THE SOUTH LINE OF SAID PARCEL 1 A DISTANCE OF 570.00 FEET TO THE SOUTHEAST CORNER OF SAID PARCEL 1, THENCE N58°21'04"E ALONG THE EAST LINE OF SAID PARCEL 1 A DISTANCE OF 199 FEET, MORE OR LESS, TO THE SOUTHERLY RIGHT OF WAY OF COUNTY ROAD NO. 1040 (AS TRAVELED), THENCE SOUTHEASTERLY ALONG SAID SOUTHERLY RIGHT OF WAY A DISTANCE OF 2330 FEET, MORE OR LESS, TO THE EAST LINE OF SAID SECTION 25, THENCE SOUTHERLY ALONG SAID EAST LINE A DISTANCE OF 300 FEET, MORE OR LESS TO THE THREAD OF THE MIDDLE FORK OF THE WILLAMETTE RIVER, THENCE NORTHWESTERLY ALONG SAID THREAD OF THE MIDDLE FORK, A DISTANCE OF 2400 FEET, MORE OR LESS, TO THE POINT OF INTERSECTION WITH THE WEST MEANDER LINE OF SAID MIDDLE FORK, THENCE NORTHWESTERLY ALONG SAID MEANDER OF THE WEST BANK OF THE MIDDLE FORK, N58°W A DISTANCE OF 800 FEET, THENCE N64°W A DISTANCE OF 1056 FEET, THENCE N40°W A DISTANCE OF 561 FEET, THENCE N30°W A DISTANCE OF 726 FEET, THENCE N5°W A DISTANCE OF 429 FEET, THENCE N32°45'W A DISTANCE OF 1188 FEET, MORE OR LESS, TO THE POINT OF INTERSECTION WITH THE NORTH LINE OF THE ISSAC BARCLY DONATION LAND CLAIM NO. 52 AND THE WEST LINE OF SAID SECTION 25, THENCE NORTHERLY ALONG THE WEST LINE OF SAID SECTION 25 A DISTANCE OF 65 FEET, MORE OR LESS, TO THE SOUTHERLY RIGHT OF WAY OF COUNTY ROAD NO. 1020, (AS TRAVELED), THENCE SOUTHEASTERLY ALONG SAID SOUTHERLY RIGHT OF WAY A DISTANCE OF 1630 FEET, MORE OR LESS, TO THE TRUE POINT OF BEGINNING, ALL IN LANE COUNTY, OREGON.

The True Consideration for this conveyance is none.

Date: October 14th 2002

Norman N. McDougal Partner

THIS INSTRUMENT WILL NOT ALLOW USE OF THE PROPERTY DESCRIBED IN THIS INSTRUMENT IN VIOLATION OF APPLICABLE LAND USE LAWS AND REGULATIONS. BEFORE SIGNING OR ACCEPTING THIS INSTRUMENT, THE PERSON ACQUIRING FEE TITLE TO THE PROPERTY SHOULD CHECK WITH THE APPROPRIATE CITY OF COUNTY PLANNING DEPARTMENT TO VERIFY USES AND DETERMINE ANY LIMITS ON LAWSUITS AGAINST FARMING OR FOREST PRACTICES AS DEFINED IN ORS 30.930.

STATE OF OREGON)
)ss.
County of Lane)



On 14th, October, 2002, personally appeared the above named Norman N. McDougal, Partner of McDougal Bros. Investments a General Partnership consisting of Norman N. McDougal and Melvin L. McDougal and acknowledged the foregoing instrument to be a voluntary act and deed.

Geri A. Betz
Notary Public for Oregon
My Commission Expires: 4-30-05

11.300 18-02-25

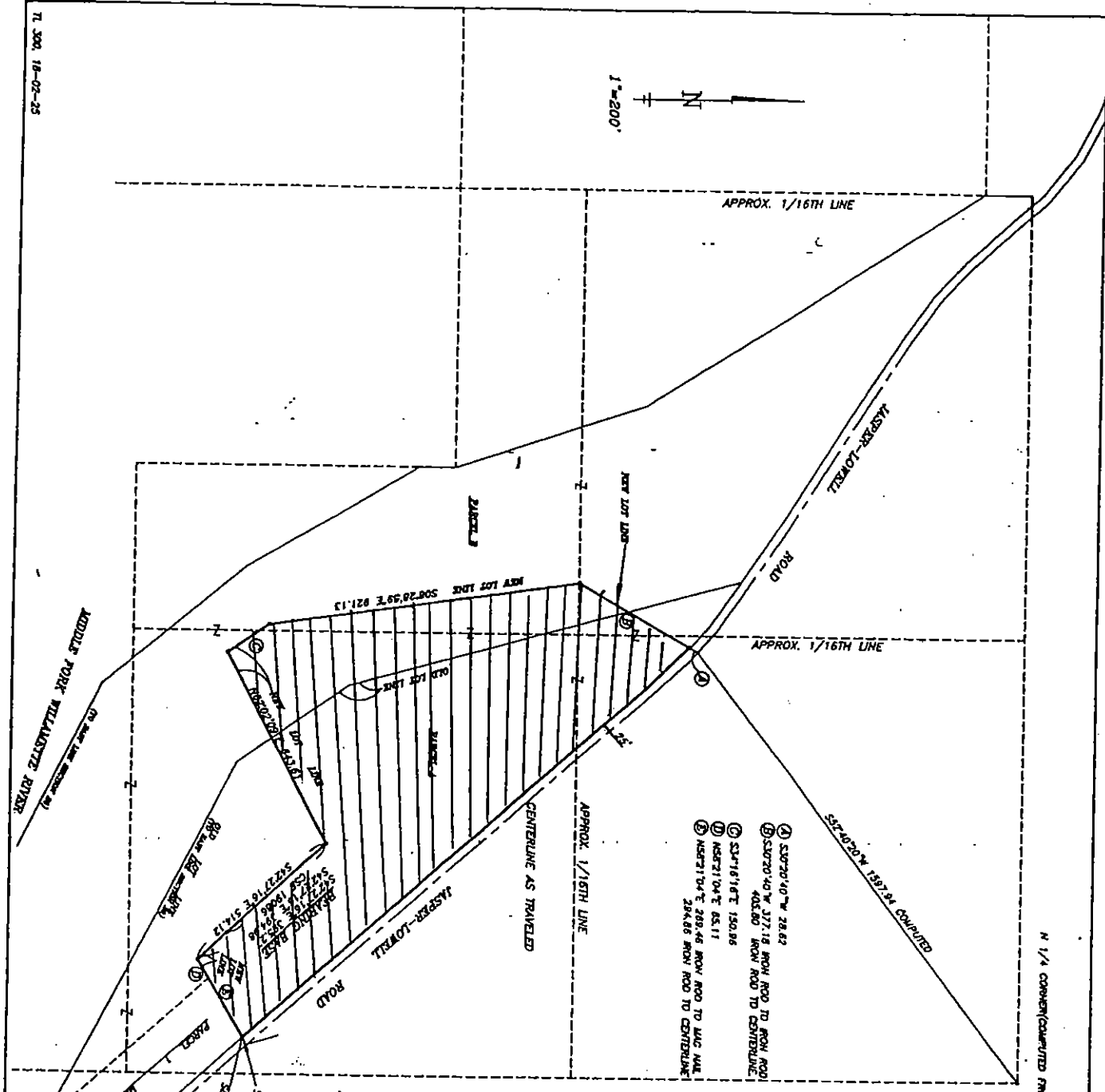
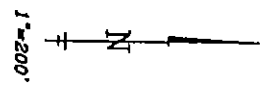

- ① S07°20'40" W 28.62
- ② S07°20'40" W 217.18 FROM ROAD TO ROAD 403.80 FROM ROAD TO CENTERLINE
- ③ S34°16'16" E 150.86
- ④ N58°21'04" E 65.11
- ⑤ N58°21'04" E 288.48 FROM ROAD TO W.C. HALL 284.68 FROM ROAD TO CENTERLINE

N 1/4 CORNER(COMPUTED FROM CSR 18088)

APPROX. NORTH-SOUTH CENTERLINE SECTION 25

MAP OF SURVEY
FOR
McDOUGAL BROS., INC.
IN THE N1/2, SECTION 25
T18S, R21W, N14
JULY, 2002
PROJECT LINE ADJUSTMENT

LAND COUNTY SEAL/STAMP OFFICE
CLERK **SHIRLEY**
LAND DATE 02.
C

SURVEY NARRATIVE
THE PURPOSE OF THIS SURVEY WAS TO DO A PROPERTY LINE ADJUSTMENT BETWEEN PARCELS DETERMINED TO BE LEGAL LOTS BY LAKE COUNTY LAND MANAGEMENT DIVISION. ADJUSTED LOT LINES AS PER DIRECTION OF CLIENT AND SET MONUMENTS AS SHOWN.

- LEGEND**
- SET 5/8" X 3/4" IRON ROD WITH YELLOW PLASTIC CAP 131103"
 - ROUND 5/8" IRON ROD UNLESS OTHERWISE NOTED
 - NEW LOT LINE

SET 2 1/2" WAG NAIL WITH 1 1/4" STEEL WASHER STAMPED 731103"
E 1/4 CORNER SECTION 25
FOUND 2 1/2" IRON ROD
ON 1" IRON PIPE, C.D. 1940

REGISTERED PROFESSIONAL LAND SURVEYOR
D. S. S. S.
DAVID S. SWANSON
RENEWAL DATE: 6-30-04

PREPARED BY: SWANSON LAND SURVEYING
201 SW 10TH AVE
EUGENE, OREGON 97404

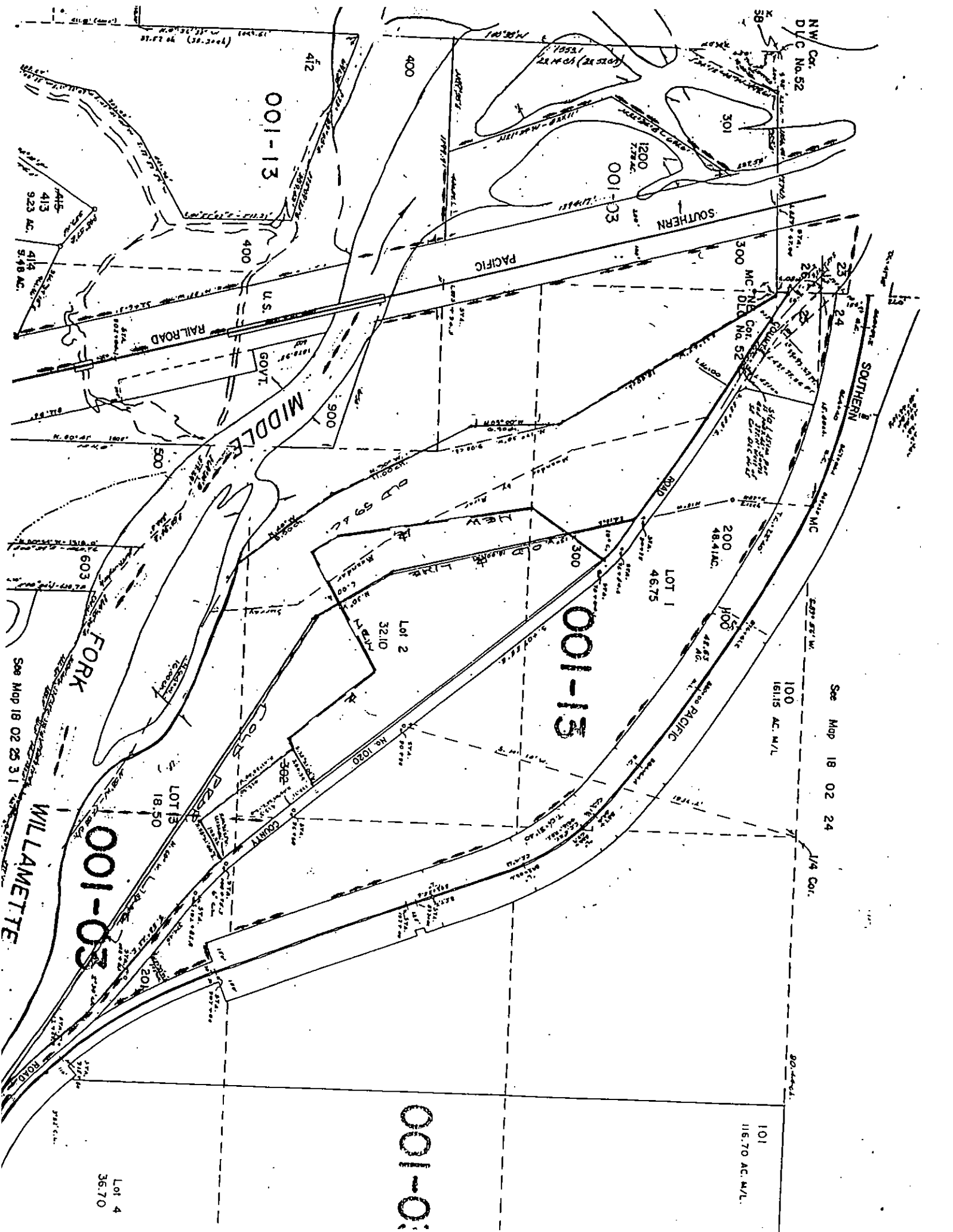

NW Cor.
D.L.C. No. 52

SOUTHERN
PACIFIC

U.S.
GOVT.
RAILROAD

001-13

001-03

001-13

MIDDLE
FORK

001-03

WILLAMETTE
ROAD

001-01

101
115.70 AC. M/L.

Lot 4
36.70

See Map 18 02 23 1

See Map 18 02 24

1/4 Cor.

100
161.15 AC. M/L

LOT 1
46.75

200
48.41 AC.

100
48.67 AC.

Lot 2
32.10

LOT 3
18.50

415
9.23 AC.

414
5.48 AC.

502
10.00 AC.

501
10.00 AC.

500
10.00 AC.

499
10.00 AC.

498
10.00 AC.

497
10.00 AC.

496
10.00 AC.

495
10.00 AC.

494
10.00 AC.

493
10.00 AC.

492
10.00 AC.

491
10.00 AC.

490
10.00 AC.

489
10.00 AC.

488
10.00 AC.

487
10.00 AC.

486
10.00 AC.

485
10.00 AC.

484
10.00 AC.

483
10.00 AC.

482
10.00 AC.

481
10.00 AC.

480
10.00 AC.

479
10.00 AC.

478
10.00 AC.

477
10.00 AC.

476
10.00 AC.

475
10.00 AC.

474
10.00 AC.

473
10.00 AC.

472
10.00 AC.

471
10.00 AC.

470
10.00 AC.

469
10.00 AC.

468
10.00 AC.

467
10.00 AC.

466
10.00 AC.

465
10.00 AC.

464
10.00 AC.

463
10.00 AC.

462
10.00 AC.

461
10.00 AC.

460
10.00 AC.

459
10.00 AC.

458
10.00 AC.

457
10.00 AC.

456
10.00 AC.

455
10.00 AC.

454
10.00 AC.

453
10.00 AC.

452
10.00 AC.

451
10.00 AC.

450
10.00 AC.

449
10.00 AC.

448
10.00 AC.

447
10.00 AC.

446
10.00 AC.

445
10.00 AC.

444
10.00 AC.

443
10.00 AC.

442
10.00 AC.

441
10.00 AC.

440
10.00 AC.

439
10.00 AC.

438
10.00 AC.

437
10.00 AC.

436
10.00 AC.

435
10.00 AC.

434
10.00 AC.

433
10.00 AC.

432
10.00 AC.

431
10.00 AC.

430
10.00 AC.

429
10.00 AC.

428
10.00 AC.

427
10.00 AC.

426
10.00 AC.

425
10.00 AC.

424
10.00 AC.

423
10.00 AC.

422
10.00 AC.

421
10.00 AC.

420
10.00 AC.

419
10.00 AC.

418
10.00 AC.

417
10.00 AC.

416
10.00 AC.

415
10.00 AC.

414
10.00 AC.

413
10.00 AC.

412
10.00 AC.

411
10.00 AC.

410
10.00 AC.

409
10.00 AC.

408
10.00 AC.

407
10.00 AC.

406
10.00 AC.

405
10.00 AC.

404
10.00 AC.

403
10.00 AC.

402
10.00 AC.

401
10.00 AC.

400
10.00 AC.

399
10.00 AC.

398
10.00 AC.

397
10.00 AC.

396
10.00 AC.

395
10.00 AC.

394
10.00 AC.

393
10.00 AC.

392
10.00 AC.

391
10.00 AC.

390
10.00 AC.

389
10.00 AC.

388
10.00 AC.

387
10.00 AC.

386
10.00 AC.

385
10.00 AC.

384
10.00 AC.

383
10.00 AC.

382
10.00 AC.

381
10.00 AC.

380
10.00 AC.

379
10.00 AC.

378
10.00 AC.

377
10.00 AC.

376
10.00 AC.

375
10.00 AC.

374
10.00 AC.

373
10.00 AC.

372
10.00 AC.

371
10.00 AC.

370
10.00 AC.

369
10.00 AC.

368
10.00 AC.

367
10.00 AC.

366
10.00 AC.

365
10.00 AC.

364
10.00 AC.

363
10.00 AC.

362
10.00 AC.

361
10.00 AC.

360
10.00 AC.

359
10.00 AC.

358
10.00 AC.

357
10.00 AC.

356
10.00 AC.

355
10.00 AC.

354
10.00 AC.

353
10.00 AC.

352
10.00 AC.

351
10.00 AC.

350
10.00 AC.

349
10.00 AC.

348
10.00 AC.

347
10.00 AC.

346
10.00 AC.

345
10.00 AC.

344
10.00 AC.

343
10.00 AC.

342
10.00 AC.

341
10.00 AC.

340
10.00 AC.

339
10.00 AC.

338
10.00 AC.

337
10.00 AC.

336
10.00 AC.

335
10.00 AC.

334
10.00 AC.

333
10.00 AC.

332
10.00 AC.

331
10.00 AC.

330
10.00 AC.

329
10.00 AC.

328
10.00 AC.

327
10.00 AC.

326
10.00 AC.

325
10.00 AC.

324
10.00 AC.

323
10.00 AC.

322
10.00 AC.

321
10.00 AC.

320
10.00 AC.

319
10.00 AC.

318
10.00 AC.

317
10.00 AC.

316
10.00 AC.

315
10.00 AC.

314
10.00 AC.

313
10.00 AC.

312
10.00 AC.

311
10.00 AC.

310
10.00 AC.

309
10.00 AC.

308
10.00 AC.

307
10.00 AC.

306
10.00 AC.

305
10.00 AC.

304
10.00 AC.

303
10.00 AC.

302
10.00 AC.

301
10.00 AC.

300
10.00 AC.

299
10.00 AC.

298
10.00 AC.

297
10.00 AC.

296
10.00 AC.

295
10.00 AC.

294
10.00 AC.

293
10.00 AC.

292
10.00 AC.

291
10.00 AC.

290
10.00 AC.

289
10.00 AC.

288
10.00 AC.

287
10.00 AC.

286
10.00 AC.

285
10.00 AC.

284
10.00 AC.

283
10.00 AC.

282
10.00 AC.

281
10.00 AC.

280
10.00 AC.

279
10.00 AC.

278
10.00 AC.

277
10.00 AC.

276
10.00 AC.

275
10.00 AC.

274
10.00 AC.

273
10.00 AC.

272
10.00 AC.

271
10.00 AC.

270
10.00 AC.

269
10.00 AC.

268
10.00 AC.

267
10.00 AC.

266
10.00 AC.

265
10.00 AC.

264
10.00 AC.

AFTER RECORDING RETURN TO
FIDELITY NATIONAL TITLE INSURANCE
COMPANY OF OREGON
PO BOX 10827
EUGENE, OR 97440

Division of Chief Deputy Clerk
Lane County Deeds and Records

2002-079702



\$26.00

00346269200200797020010018

10/15/2002 09:29:12 AM

RPR-DEED Cnt=1 Stn=8 CASHIER 01
\$5.00 \$11.00 \$10.00

After Recording Return To:

Until a change is requested, all tax statements
shall be sent to the following address:

Laurelwood Academy
P.O. Box 518
Creswell, OR 97426

BARGAIN AND SALE DEED

McDougal Bros. Investments a General Partnership consisting of Norman N. McDougal and Melvin L. McDougal, Grantor, conveys to Laurelwood Academy, INC., an Oregon Nonprofit Corporation, Grantee, all their rights, title and interest in the real property situated in Lane County, Oregon, described as:

BEGINNING AT A POINT 969.0 FEET SOUTH AND 1270.7 FEET WEST OF THE NORTH 1/4 CORNER OF SECTION 25, TOWNSHIP 18 SOUTH, RANGE 2 WEST, WILLAMETTE MERIDIAN, SAID POINT BEING IN THE CENTER OF COUNTY ROAD NO. 1020(AS TRAVELED) THENCE S30°20'40"W A DISTANCE OF 405.80 FEET, THENCE S08°28'59"E A DISTANCE OF 921.13, THENCE S34°16'16"E A DISTANCE OF 150.96 FEET, THENCE N62°02'09"E A DISTANCE OF 643.61 FEET, THENCE S42°27'16"E A DISTANCE OF 514.12 FEET, THENCE N58°21'04"E A DISTANCE OF 294.86 FEET TO THE CENTER OF SAID COUNTY ROAD NO. 1020(AS TRAVELED), THENCE NORTHWESTERLY ALONG THE CENTER OF SAID COUNTY ROAD NO. 1020 A DISTANCE OF 1760 FEET, MORE OR LESS, TO THE POINT OF BEGINNING ALL IN LANE COUNTY, OREGON. EXCEPTING THEREFROM ANY PORTION LYING IN THE RIGHT OF WAY OF COUNTY ROAD NO. 1020.

The true consideration for the conveyance is other.

THIS INSTRUMENT WILL NOT ALLOW USE OF THE PROPERTY DESCRIBED IN THIS INSTRUMENT IN VIOLATION OF APPLICABLE LAND USE LAWS AND REGULATIONS. BEFORE SIGNING OR ACCEPTING THIS INSTRUMENT, THE PERSON ACQUIRING FEE TITLE TO THE PROPERTY SHOULD CHECK WITH THE APPROPRIATE CITY OF COUNTY PLANNING DEPARTMENT TO VERIFY USES AND DETERMINE ANY LIMITS OR LAWSUITS AGAINST FARMING OR FOREST PRACTICES AS DEFINED IN ORS 30.930

Date: 10-14-02

Norman N. McDougal
Norman N. McDougal, Partner

STATE OF OREGON)

County of Lane)

On 14th October 2002, personally appeared the above named

Norman N. McDougal, Partner, McDougal Bros. Investment a General Partnership consisting of Norman N. McDougal and Melvin L. McDougal and acknowledged the foregoing instrument to be a voluntary act and deed.

Geri A. Betz
Notary Public for Oregon
My Commission Expires: 4-30-05

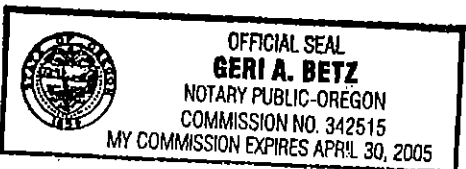

This instrument filed for record by Fidelity National Title Company as an accommodation only. It has not been examined as to its execution or as to its effect upon the title.

02/10-25 - 3/3



SITE

LANE COUNTY PLANNING COMMISSION

STAFF REPORT



HEARING DATE: December 2, 2003

FILE No. 03-5269

REPORT DATE: November 25, 2003

LAND MANAGEMENT DIVISION
http://www.LaneCounty.org/PW_LMD

I. APPLICATION DESCRIPTION

A. Owner/Applicant:

Laurelwood Academy Inc.
38950 S.W. Laurelwood Rd.
Gaston, Or. 97119

Agent:

Land Planning Consultants
1071 Harlow Rd.
Springfield, Or. 97477

B. Proposal

Proposed Minor Amendment to the Rural Comprehensive Plan from a Forest Land Designation to Agricultural Land and Rezone from F-2/RCP Impacted Forest Lands Zone to E-25/RCP Exclusive Farm Use Zone.

II. RECOMMENDATION

Based on information in the submittal, approval appears warranted. Staff recommends:

1. Approval of the Plan Amendment from Forest Land to Agricultural Land
2. Approval of the zone change from F-2/Impacted Forest Lands to E-25/Exclusive Farm Use

III. SITE AND PLANNING PROFILE

A. Subject Property

Map 18-02-25, tax lot 300 (a 20-acre portion)

The subject property is the result of a property line adjustment performed in October of 2002. The adjustment was reviewed by LMD staff (per PA 02-5839, attached to the applicant's submittal), and found to be in compliance with applicable laws pertaining to such adjustments.

B. Zoning

Located on Plot 494. Zoned Impacted Forest Lands, F-2/RCP. A portion of the property is also within the regulated 100-year floodhazard area (LC 16.244), as well as the Willamette River Greenway (LC 16.254). Those zone designations will remain unchanged.

C. Site Characteristics

The site consists of 20 acres located on Jasper-Lowell Road, approximately 2.5 miles southeast of the unincorporated Community of Jasper. The subject parcel is directly across the road, and south of, the Cascade Pacific Industries mill site, which is located at 37385 Jasper-Lowell Road.



The parcel is undeveloped, except for an asphalt apron onto the county road. Approximately 17 acres are in orchard and pasture use, and three acres are covered by deciduous trees and the apron.

The parcel contains three soil types, none of which are rated for Doug Fir production. The soils do have a range from Class 1 through IV for agricultural capability, meeting the definition of agricultural land for Western Oregon. Refer to the attached applicant's statement, and exhibits, for more details on the site.

D. Surrounding Area

Land to the northeast and across the county road is zoned RI/Rural Industrial (Cascade Pacific Industries mill). F-2/Impacted Forest Lands zoned land is found adjacent to the northwest and south, the latter having a dwelling.

The Middle Fork of the Willamette River is located approximately 450' west of the subject parcel. Land west of the river is zoned E-25/Exclusive Farm Use, with some RR-5 & RR-2/Rural Residential land to the west, developed with dwellings.

E. Services

Fire: Dexter RFPD
Police: County, State
Water & Sewer: On site septic and well
School: Pleasant Hill No. 1
Telephone: QWest
Power: Emerald PUD
Access: Jasper-Lowell Rd. (County)

F. Referral Comments Received:

No referral responses were received from any agency or neighboring landowners, as of the writing of this report.

IV. APPROVAL CRITERIA & ANALYSES

A. Character of the Request

The proposal is a Minor Amendment pursuant to Lane Code 16.400(6)(h) and involves a rezoning subject to LC 16.252.

Rural Comprehensive Plan policies affecting the proposal, as well as Plan amendment and rezoning criteria, are recited and discussed in the applicant's statements attached to this Staff Report, and so will not be repeated here.

No exception to any Goal, resource or otherwise, is necessary. This is simply a proposed change from one resource zone to another.

B. Evaluation

This request proposes to convert a 20-acre parcel from Impacted Forest Lands to Agricultural Lands. Doing so would enable development of the parcel to those uses allowable in the E-25 zone, LC 16.212, and OAR 660-33-120.

This application seeks to remedy an apparent error in the Plan designation, as well as to implement Plan policies (LC 16.400(6)(h)(iii)(bb)(i-i) & (-v-iv)). The parent parcel, which consisted of approximately 100 acres, was zoned FF-20/Farm-Forestry 20 District (LC 10.105) in the mid 1970's. The FF-20 zone allowed a

mixture of farm and forest uses. However, when the county rezoned all areas outside of the UGB's in 1984, the effort was one of "high-volume" and of a "broad-brush" approach. A forest designation was given, probably to match the other forest zoned lands found north of the river. The 1984 version of the F-2 ordinance contained a "searchlight" provision, which allowed many of the farm uses now allowed in EFU zoned land, in effect a mixed-farm/forest zone. When mixed uses appeared, a property was often given a F-2 designation. With the elimination of the searchlight provision in the late 1980's (found to be a goal violation), the current zone designation became inappropriate for a 20-acre parcel with no forest capability rating, decent farm soils, and a history of farm use.

Concerning the Lane Code Plan amendment and rezoning criteria, the applicant recites the appropriate standards and responds to them in detail in his statement. Staff concurs with this analyses and arguments. As evidenced by the existing orchard and pasture, a history of farm deferral, and, the subject property is far more farm use than forest use in character. The proposed Plan and zone change to Agricultural land and E-25 more accurately reflects the character of the property and appears warranted.

V. CONCLUSIONS

A. Summary and Recommendation

A history of farm use, farm capable soils, and low (unrated) forest capability indicates that a classification of the land to Agricultural Land and E-25 is appropriate.

B. Attachments to Staff Report

1. Notice map
2. Applicant's statement with exhibits

C. Materials to be Part of the Record

1. Staff Report and attachments.
2. Applicant's statement with all exhibits.
3. File PA 03-5269
4. Lane Code Chapter 14 and sections 16.211, 16.212, 16.252 and 16.400.

ection 25 T18S. R2WWM.

LANE COUNTY

1"=400'

18 02 25

8-11-04
BY: JSC G.C. S.P.C.C.
(CHECK PCS TO 1000)

JASPER-LOWELL RD.

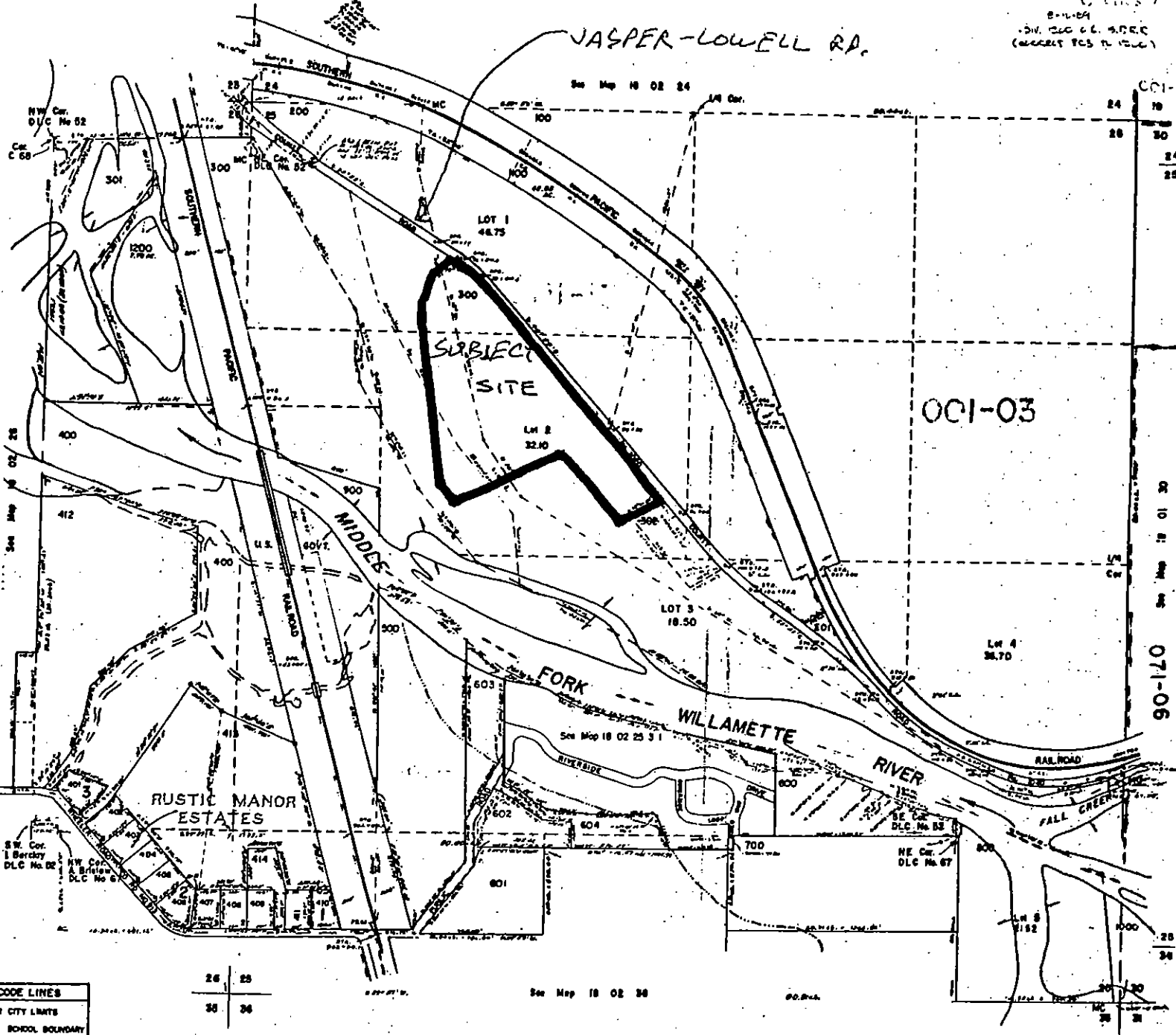

CODE LINES
 - CITY LIMITS
 - SCHOOL BOUNDARY
 - ALL OTHER CODES

26	25
28	24

See Map 18 02 30



001-03
 071-06

"F-2/IMPACTED FOREST LANDS"
TO 493

"E-25/EXCLUSIVE FARM USE"

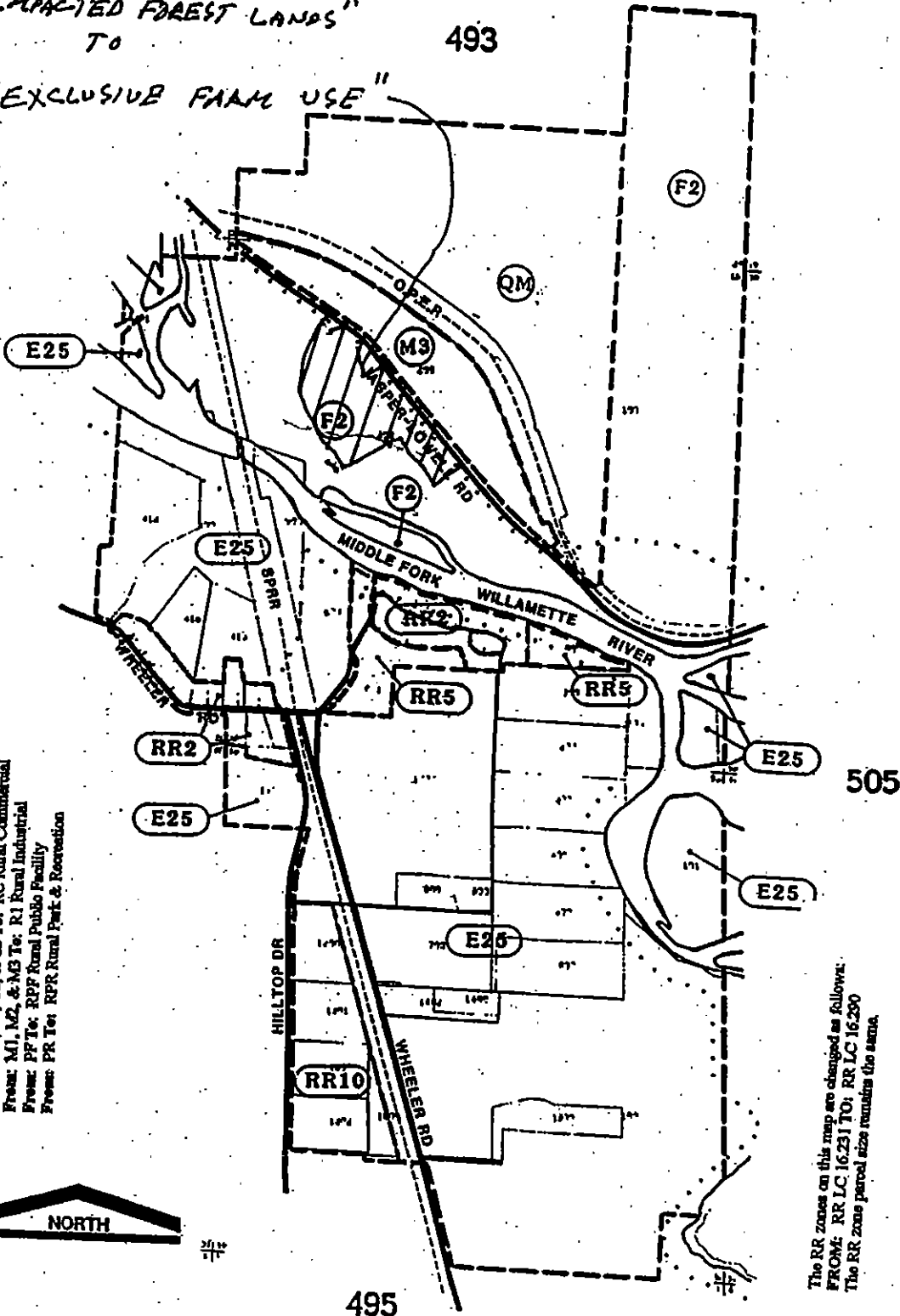

The zones on this map are changed as follows:
 From: RG, RA, and Te; To: RR2
 From: CR, C1, C2, & C3 To: RC Rural Commercial
 From: M1, M2, & M3 To: R1 Rural Industrial
 From: PF To: RPP Rural Public Facility
 From: PR To: RPR Rural Park & Recreation

The RR zones on this map are changed as follows:
 FROM: RR LC 16.231 TO: RR LC 16.230
 The RR zone parcel size remains the same.



lane county



OFFICIAL ZONING MAP

PLOT# 494

Township Range Section	
18 02 25	18 02 36

ORIGINAL ORD. # _____ PA 884 DATE 2/29/1984 FILE # _____
 REVISION # _____ ORD # _____

"FOREST LAND"
TO
"AGRICULTURAL
LAND"

493

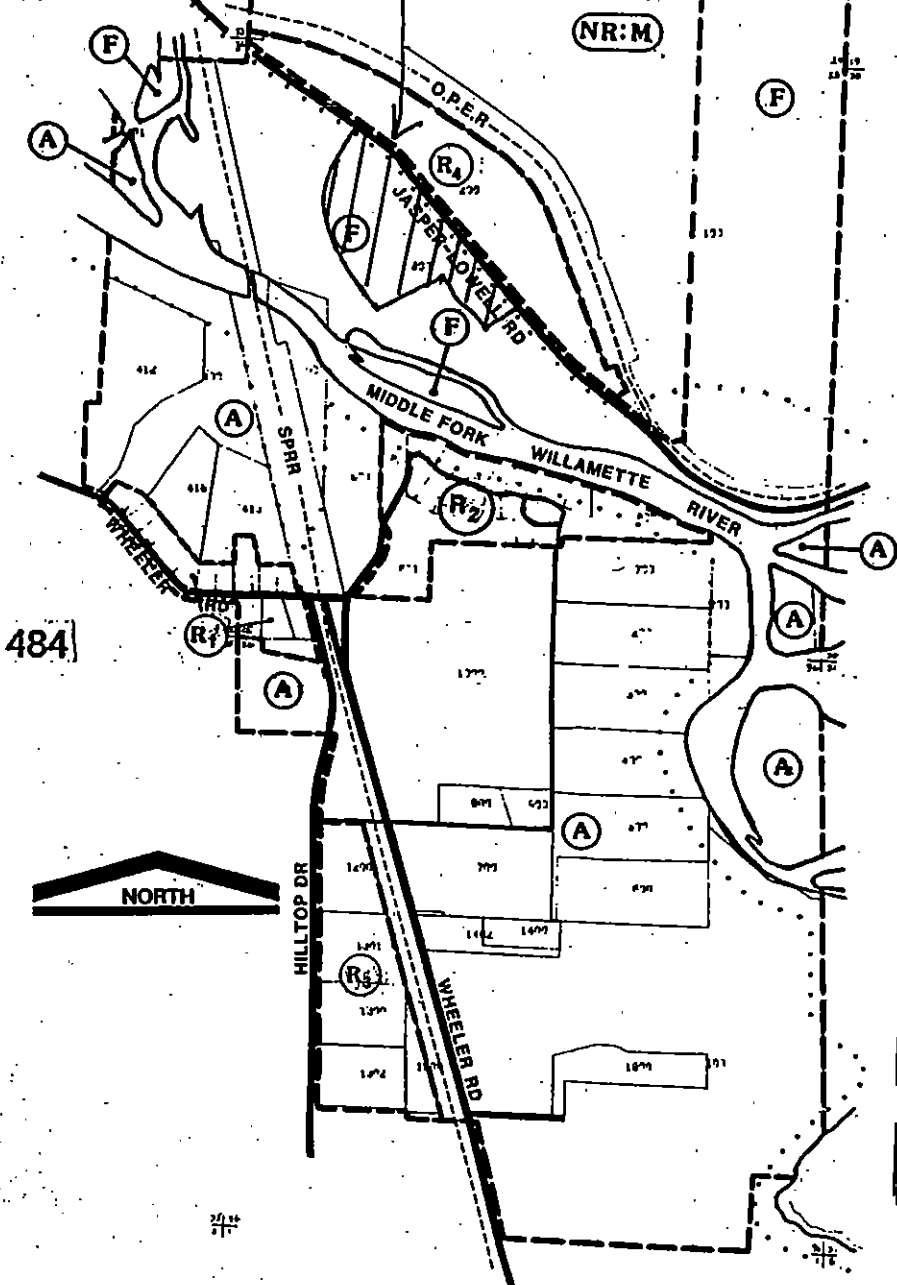

NR:M

484

505



495

lane county



OFFICIAL PLAN MAP

PLOT# 494

Township Range Section

18 02 25

18 02 36

ORIGINAL ORD. # PA 884

DATE 2/29/1984

FILE #

REVISION # ORD #

DATE

FILE #